

SMEERPUTTEN

VEELZIJDIGE PREFAB BETONNEN PUTTEN



WERKPUT

FOSSE MECANIQUE

FOSSES DE GARAGE

**FOSSES PREFAB EN BETON
A MULTIPLES APPLICATIONS**

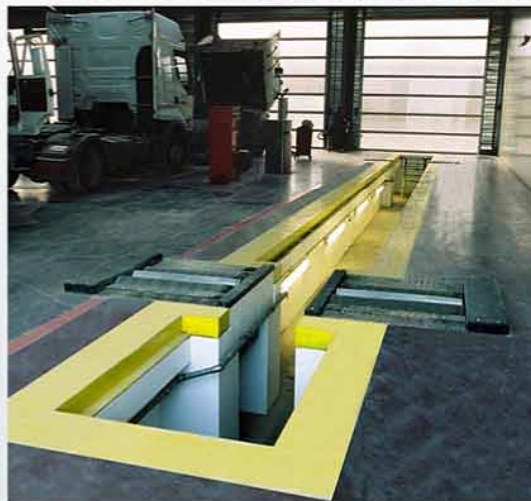

PUT VOOR REMTESTBANK

**FOSSE POUR
BANC DE FREINAGE**



**VUILROOSTER VOOR
WATERZUIVERING**

**DEGRILLEUR POUR
STATION D'EPURATION**



PREFAB VIJVER

**DECANTEUR POUR
PISCICULTURE**



SLIBVANG VOOR SELF CARWASH

**DEBOURBEUR POUR
AIRE DE LAVAGE**

ENKELVOUDIGE PUTTEN

FOSSES SIMPLES

TYPE SK1

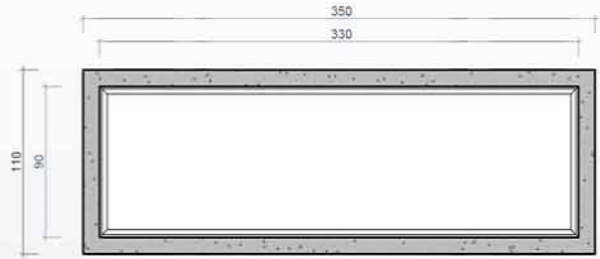

	L/Lo	B/La	H/Ha
SK1 inwendig/intérieur	3300	900	1400
GALVA KADER & ROOSTER	KLASSE/CLASSE	A15	60
CADRE & GRILLE GALVA	KLASSE/CLASSE	B125	70
	KLASSE/CLASSE	C250	80
	KLASSE/CLASSE	D400	100

afmetingen in mm / dimensions en mm

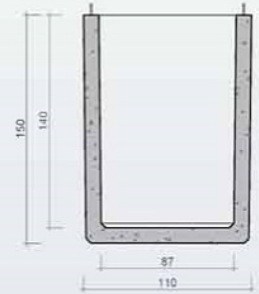

TYPE SK2

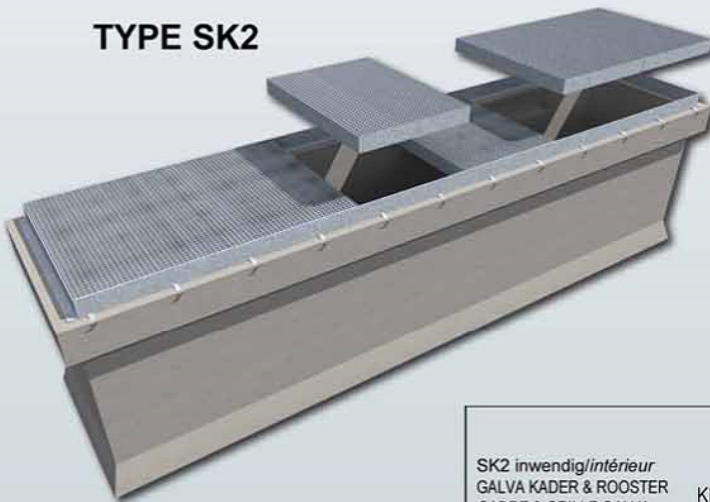

	L/Lo	B/La	H/Ha
SK2 inwendig/intérieur	5500	1050	1400
GALVA KADER & ROOSTER	KLASSE/CLASSE	A15	60
CADRE & GRILLE GALVA	KLASSE/CLASSE	B125	70
	KLASSE/CLASSE	C250	90
	KLASSE/CLASSE	D400	130

afmetingen in mm / dimensions en mm

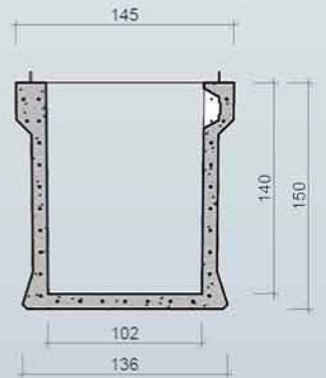

TYPE SK4

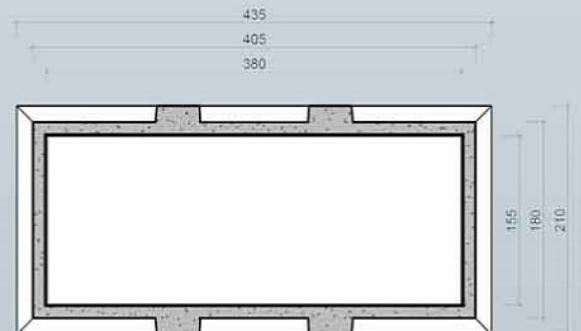
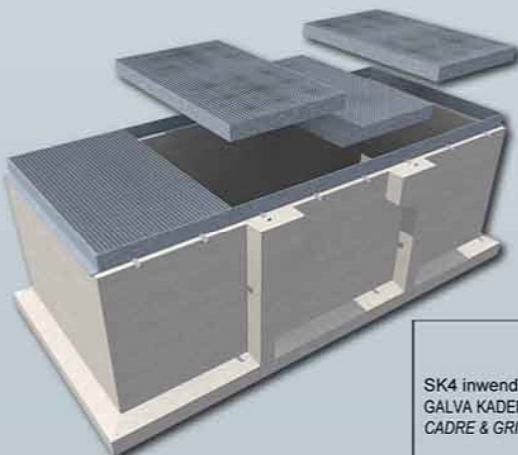

	L/Lo	B/La	H/Ha
SK4 inwendig/intérieur	3800	1550	1250
GALVA KADER & ROOSTER	KLASSE/CLASSE	A15	60
CADRE & GRILLE GALVA	KLASSE/CLASSE	B125	70

afmetingen in mm / dimensions en mm

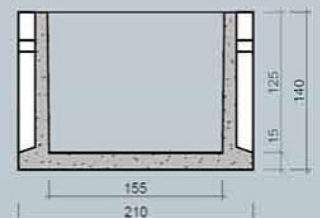

GEKOPPELDE PUTTEN

TYPE SK2

FOSSES MODULAIRES

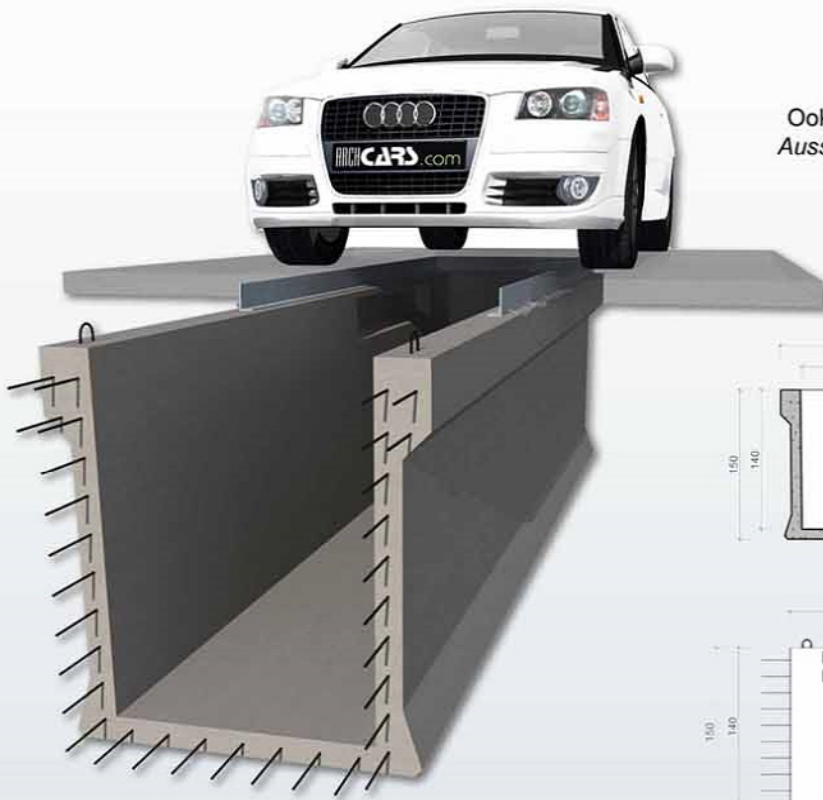

Ook verkrijgbaar zonder uitsparingen voor verlichting
Aussi disponible avec ou sans réservations d'éclairage

Kortere elementen op aanvraag
Éléments courts sur demande
(min. 2,50 m / 25 cm)

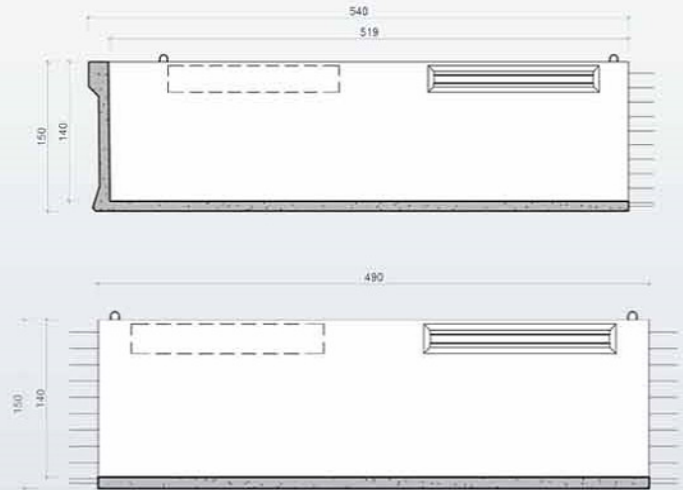

Uitgraven bouwput en fundering
Excavation fosse et fondation



Plaatsen eerste element
Pose premier élément



Plaatsen tweede element
Pose deuxième élément



Plaatsen verloren bekisting
Pose coffrage perdu



Aanvullen met gestabiliseerd zand
Remblais au sable stabilisé



Vullen voeg met beton
Remplissage au béton hydrofuge

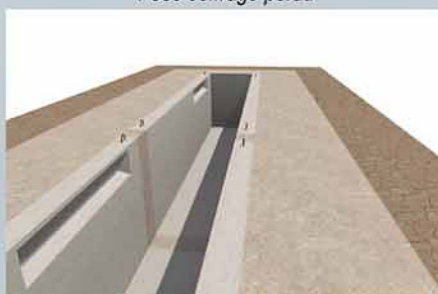

Wegnemen bekisting
Enlever coffrage

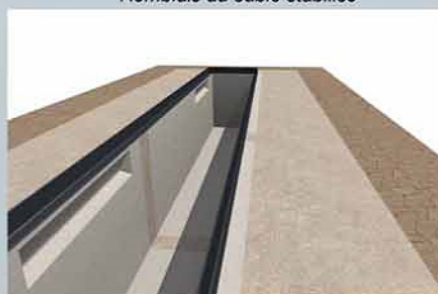

Plaatsen randprofiel
Pose profilés de bord de fosse

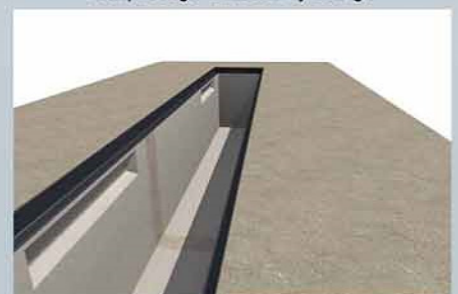

Aanstorten betonvloer
Couler dalle en béton

GEKOPPELDE PUTTEN

TYPE SK3-SK4

FOSSES MODULAIRES A ASSEMBLER SANS COFFRAGES NI FERRAILLAGE

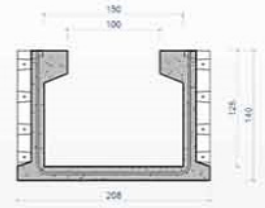
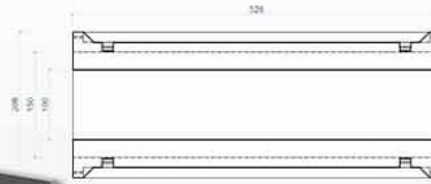
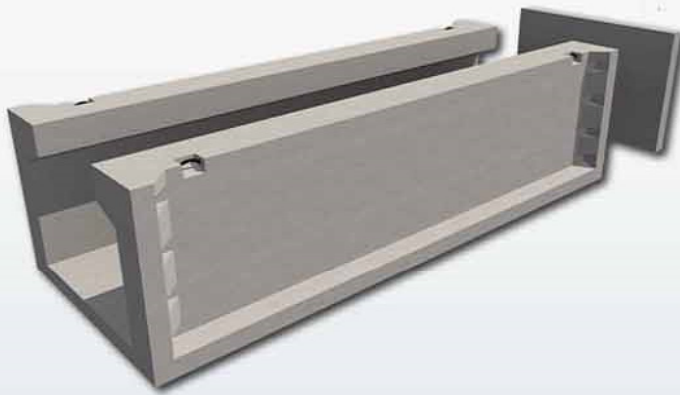

SK 3

Verbreden vrije opening bovenzijde tot 120 cm
Possibilité d'ouverture jusqu'à 120 cm

Kortere elementen op aanvraag
Eléments courts sur demande
(min. 2,50 m / 25 cm)

SK 4

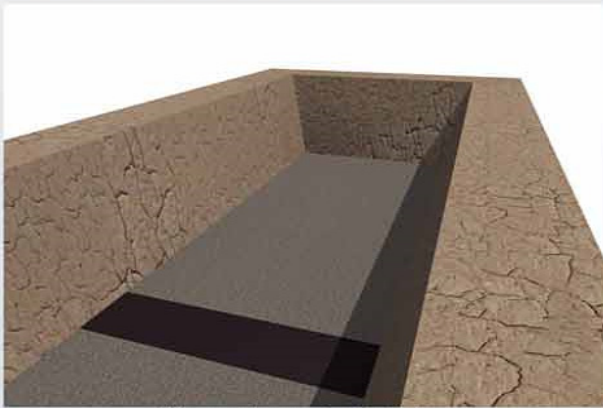
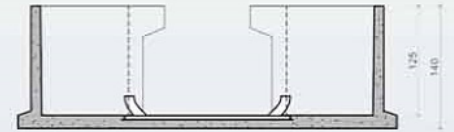
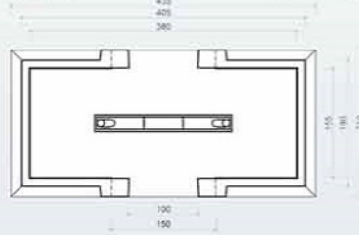

Uitgraven bouwput en fundering
Excavation fosse et fondation

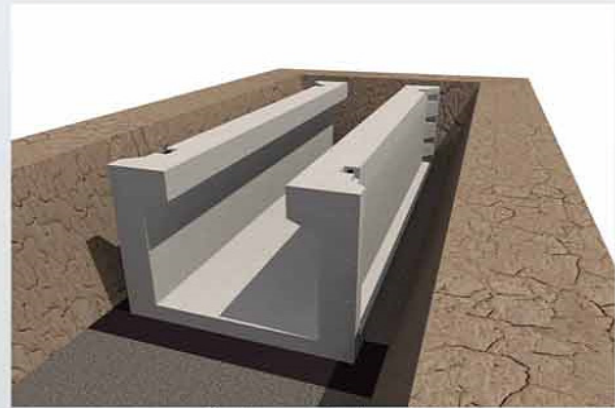

Plaatsen eerste element
Pose premier élément

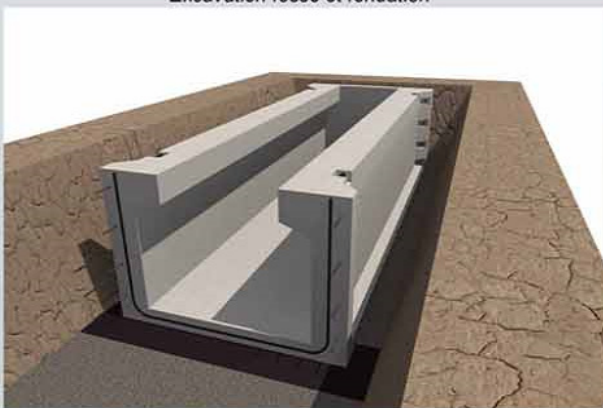

Plaatsen eindplaat
Pose plaque d'embout

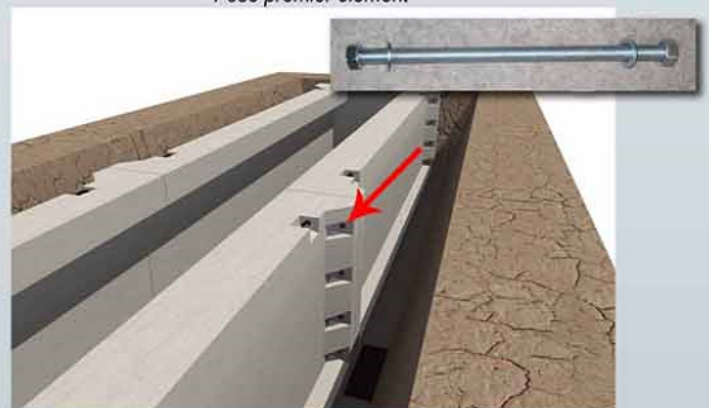

Plaatsen tweede element en vastschroeven betonnen elementen
Pose deuxième élément et assemblage par boulonnage



Aanvullen met gestabiliseerd zand en plaatsen randprofiel
Remblais au sable stabilisé et pose profilés de bord de fosse

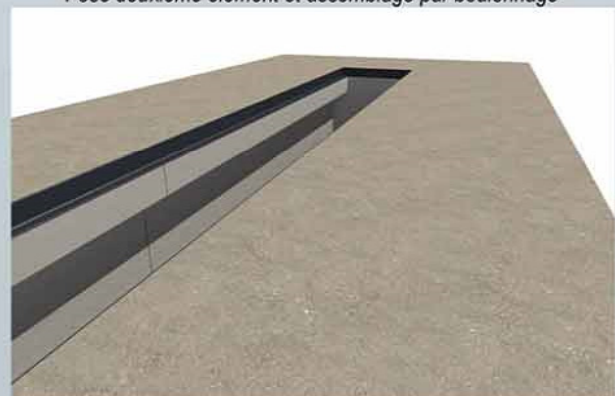

Aanstorten betonvloer
Couler dalle en béton

OPTIES



Galvatrap en alu ventilatierooster
Escalier galva et grille alu pour ventilation

OPTIONS

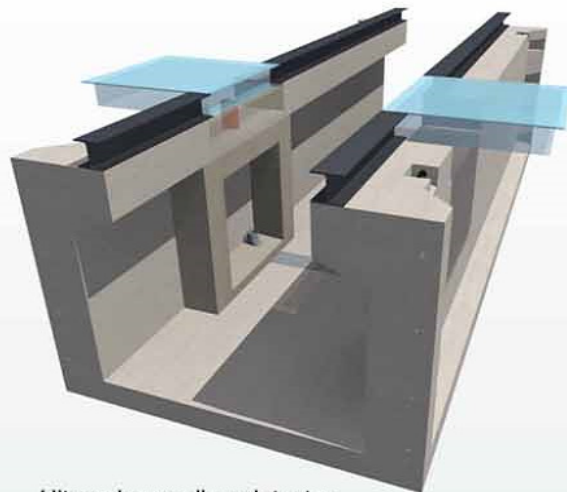

Uitsparing spelingsdetector
Pré-équipement pour réception du cadre
des plaques à jeux



Wasplaats met olieafscheider
Aire de lavage avec séparateur à hydrocarbures

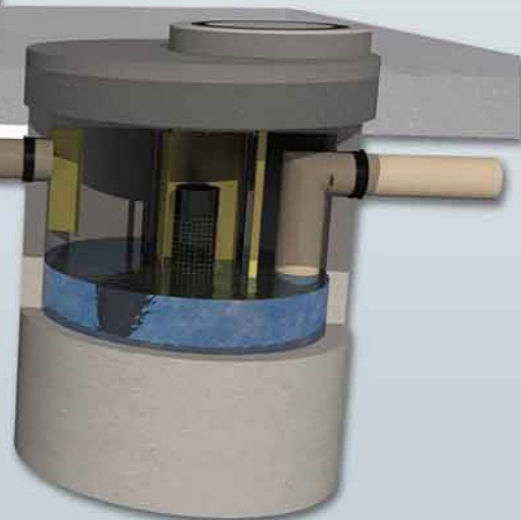

OPTIES REMTESTBANKEN

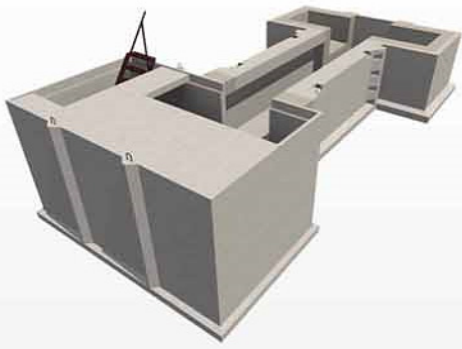

OPTIONS FOSSES BANC DE FREINAGE

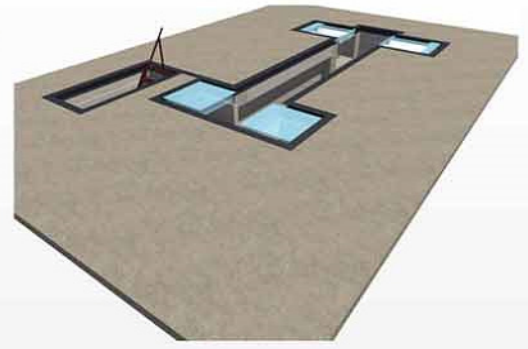

Werkput met remtestbank, spelingsdetectoren en zijdelingse toegang via prefabkelder
Fosse pour banc de freinage, plaques à jeux et accès latéral par cave préfab

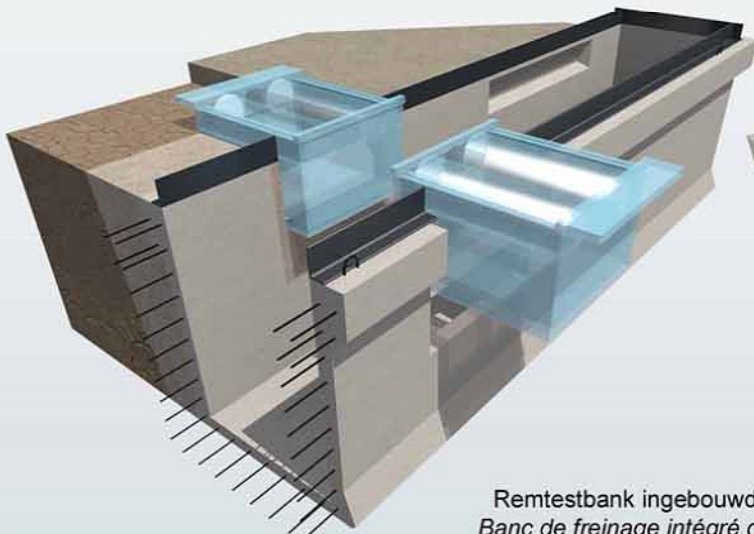

Uitsparing remtestbank SK2
Découpe banc de freinage SK2

Remtestbank ingebouwd in SK4
Banc de freinage intégré dans SK4

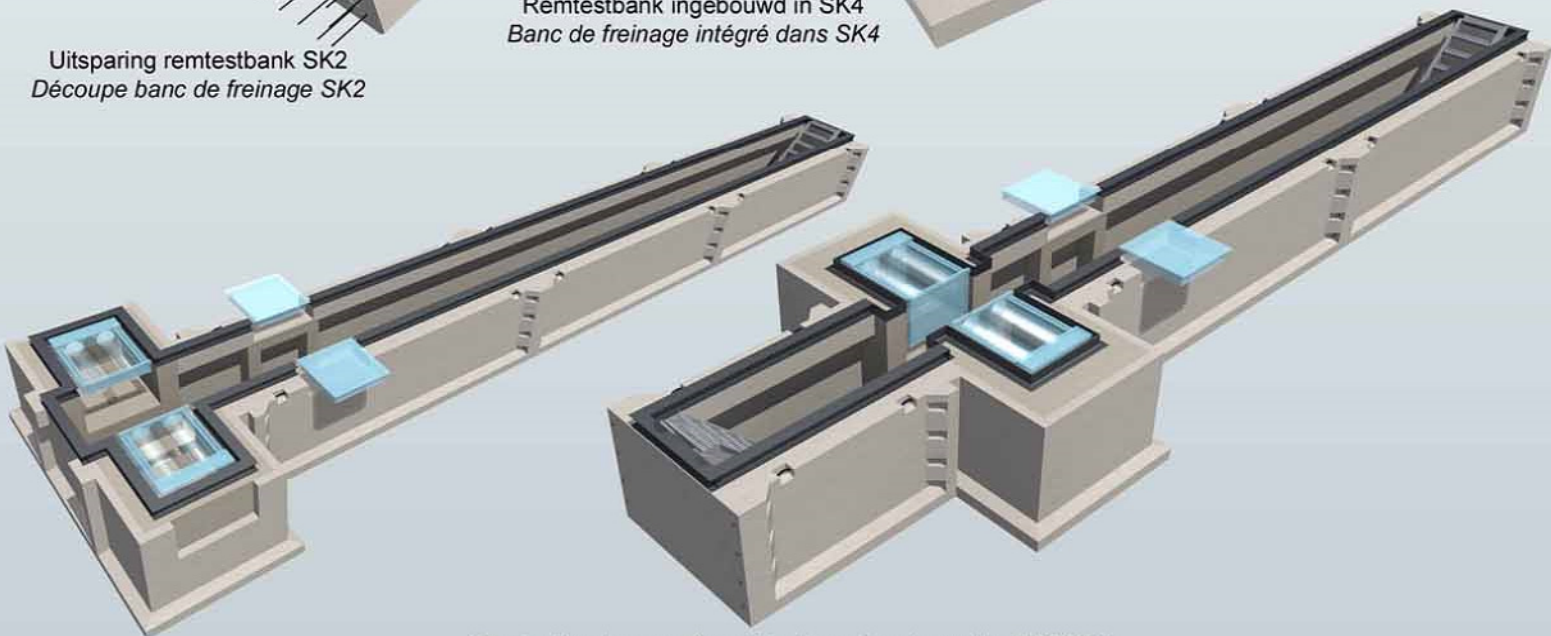
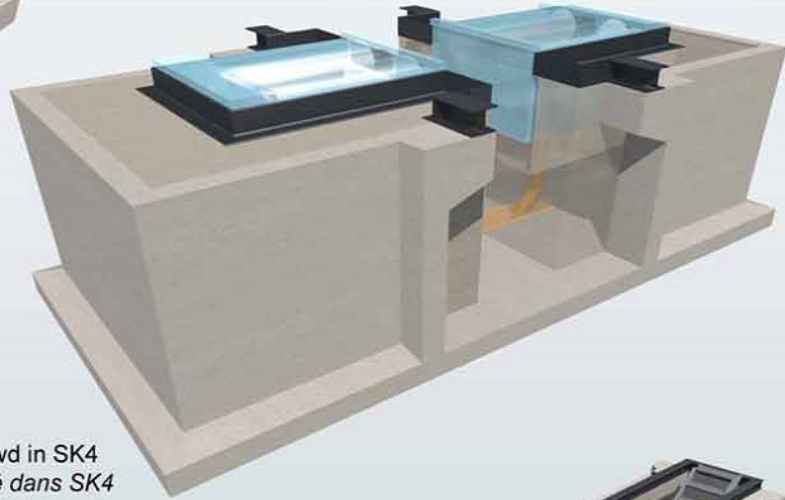

Remtestbank en spelingsdetectoren ingebouwd in SK3-SK4
Fosse banc de freinage et plaques à jeux



O BETON NV
Schaapbruggestraat 26
B-8800 Rumbeke

T 051 68 00 68
F 051 68 00 69

www.obeton.be
info@obeton.be